ADVANTEST[®]
ADVANTEST CORPORATION

R3267 Series OPT11
3GPP Level Calibration
Operation Manual

MANUAL NUMBER FOE-8370635B01

Applicable
R3264
R3267
R3273

Safety Summary

To ensure thorough understanding of all functions and to ensure efficient use of this instrument, please read the manual carefully before using. Note that Advantest bears absolutely no responsibility for the result of operations caused due to incorrect or inappropriate use of this instrument.

If the equipment is used in a manner not specified by Advantest, the protection provided by the equipment may be impaired.

- **Warning Labels**

Warning labels are applied to Advantest products in locations where specific dangers exist. Pay careful attention to these labels during handling. Do not remove or tear these labels. If you have any questions regarding warning labels, please ask your nearest Advantest dealer. Our address and phone number are listed at the end of this manual.

Symbols of those warning labels are shown below together with their meaning.

DANGER: Indicates an imminently hazardous situation which will result in death or serious personal injury.

WARNING: Indicates a potentially hazardous situation which will result in death or serious personal injury.

CAUTION: Indicates a potentially hazardous situation which will result in personal injury or a damage to property including the product.

- **Basic Precautions**

Please observe the following precautions to prevent fire, burn, electric shock, and personal injury.

- Use a power cable rated for the voltage in question. Be sure however to use a power cable conforming to safety standards of your nation when using a product overseas.
- When inserting the plug into the electrical outlet, first turn the power switch OFF and then insert the plug as far as it will go.
- When removing the plug from the electrical outlet, first turn the power switch OFF and then pull it out by gripping the plug. Do not pull on the power cable itself. Make sure your hands are dry at this time.
- Before turning on the power, be sure to check that the supply voltage matches the voltage requirements of the instrument.
- Be sure to plug the power cable into an electrical outlet which has a safety ground terminal. Grounding will be defeated if you use an extension cord which does not include a safety ground terminal.
- Be sure to use fuses rated for the voltage in question.
- Do not use this instrument with the case open.
- Do not place objects on top of this product. Also, do not place flower pots or other containers containing liquid such as chemicals near this product.

Safety Summary

- When the product has ventilation outlets, do not stick or drop metal or easily flammable objects into the ventilation outlets.
- When using the product on a cart, fix it with belts to avoid its drop.
- When connecting the product to peripheral equipment, turn the power off.

- **Caution Symbols Used Within this Manual**

Symbols indicating items requiring caution which are used in this manual are shown below together with their meaning.

DANGER: Indicates an item where there is a danger of serious personal injury (death or serious injury).

WARNING: Indicates an item relating to personal safety or health.

CAUTION: Indicates an item relating to possible damage to the product or instrument or relating to a restriction on operation.

- **Safety Marks on the Product**

The following safety marks can be found on Advantest products.



: ATTENTION - Refer to manual.



: Protective ground (earth) terminal.



: DANGER - High voltage.



: CAUTION - Risk of electric shock.

- **Replacing Parts with Limited Life**

The following parts used in the instrument are main parts with limited life.

Replace the parts listed below after their expected lifespan has expired.

Note that the estimated lifespan for the parts listed below may be shortened by factors such as the environment where the instrument is stored or used, and how often the instrument is used.

The parts inside are not user-replaceable. For a part replacement, please contact the Advantest sales office for servicing.

There is a possibility that each product uses different parts with limited life. For more information, refer to Chapter 1.

Main Parts with Limited Life

Part name	Life
Unit power supply	5 years
Fan motor	5 years
Electrolytic capacitor	5 years
LCD display	6 years
LCD backlight	2.5 years
Floppy disk drive	5 years

- **Hard Disk Mounted Products**

The operational warnings are listed below.

- Do not move, shock and vibrate the product while the power is turned on. Reading or writing data in the hard disk unit is performed with the memory disk turning at a high speed. It is a very delicate process.
- Store and operate the products under the following environmental conditions.
 - An area with no sudden temperature changes.
 - An area away from shock or vibrations.
 - An area free from moisture, dirt, or dust.
 - An area away from magnets or an instrument which generates a magnetic field.
- Make back-ups of important data.
 - The data stored in the disk may become damaged if the product is mishandled. The hard disc has a limited life span which depends on the operational conditions. Note that there is no guarantee for any loss of data.

- **Precautions when Disposing of this Instrument**

When disposing of harmful substances, be sure dispose of them properly with abiding by the state-provided law.

- Harmful substances:
- (1) PCB (polycarbon biphenyl)
 - (2) Mercury
 - (3) Ni-Cd (nickel cadmium)
 - (4) Other
 - Items possessing cyan, organic phosphorous and hexadic chromium and items which may leak cadmium or arsenic (excluding lead in solder).

Example: fluorescent tubes, batteries

Environmental Conditions

This instrument should be only be used in an area which satisfies the following conditions:

- An area free from corrosive gas
- An area away from direct sunlight
- A dust-free area
- An area free from vibrations

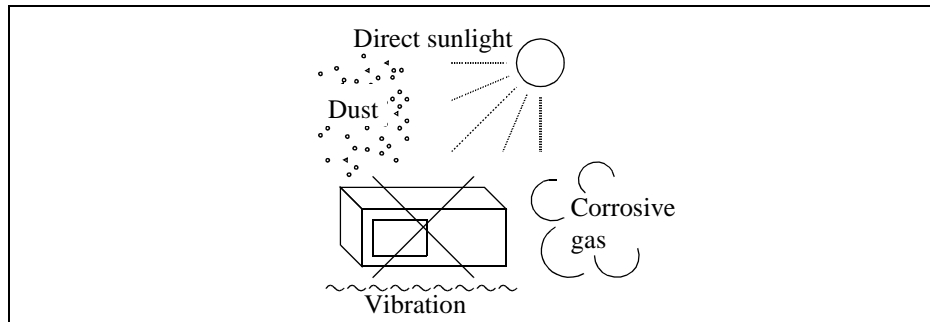

Figure-1 Environmental Conditions

- Operating position

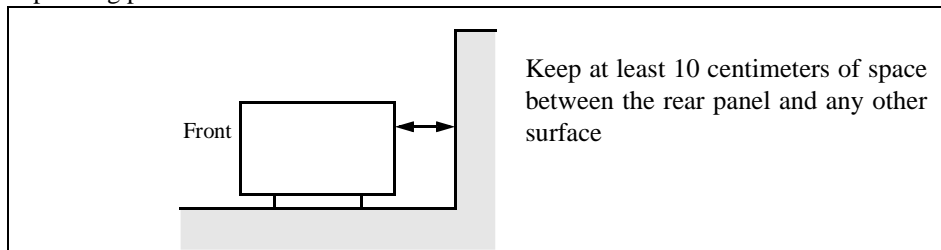

Figure-2 Operating Position

- Storage position

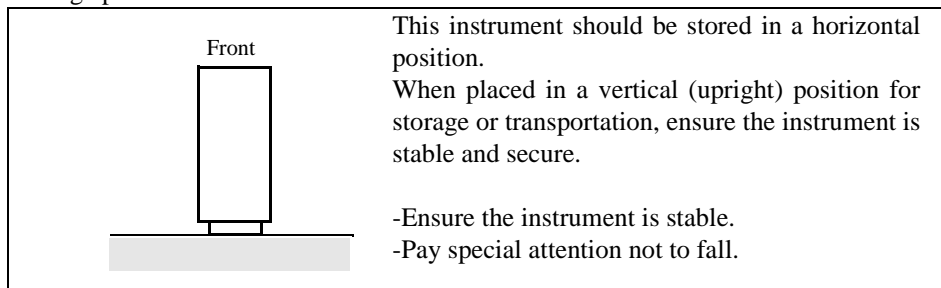

Figure-3 Storage Position

This instrument can be used safely under the following conditions:

- Altitude of up to 2000 m
- Installation Categories II
- Pollution Degree 2

TABLE OF CONTENTS

1.	INTRODUCTION	1-1
1.1	Product Description	1-1
1.2	Accessories	1-1
1.3	Precautions in Use	1-1
1.4	Calibration	1-2
2.	OPERATION	2-1
2.1	3GPP Level Calibration Data and the Setting Conditions	2-1
2.2	Using 3GPP Level Calibration Data	2-2
2.3	Measurement Sample	2-3
3.	REFERENCE	3-1
3.1	Menu Index	3-1
3.2	Menu Map	3-2
3.3	Functional Description	3-2
3.3.1	STD Menu	3-2
4.	REMOTE PROGRAMMING	4-1
4.1	GPIB Command Index	4-1
4.2	GPIB Command Codes	4-2
5.	PERFORMANCE VERIFICATION TEST	5-1
5.1	GENERAL	5-1
5.1.1	Introduction	5-1
5.1.2	Test Equipment	5-1
5.1.3	Performance Verification Test Record Sheet	5-2
5.1.4	Performance Verification Procedure	5-3
5.2	Performance Verification Test Procedure	5-4
5.2.1	Level Calibration	5-4
5.3	Performance Verification Test Record Sheet	5-8
6.	SPECIFICATIONS	6-1
APPENDIX		A-1
A.1	Error Message List	A-1
ALPHABETICAL INDEX		I-1

LIST OF ILLUSTRATIONS

No.	Title	Page
1-1	Installed Option Labels	1-1
2-1	2 GHz Modulation Signal Measurement Sample (Using the 3GPP Level Calibration Function)	2-4
5-1	Setup of Level Calibration Test	5-5

LIST OF TABLES

No.	Title	Page
2-1	Frequency Range for 3GPP Level Calibration Data and the Frequency	2-1
2-2	Setting Conditions Used for 3GPP Level Calibrations	2-1
4-1	3GPP Level Calibration (OPT11)	4-2
5-1	Equipment List	5-2
5-2	List for SG and PM Correction Data Setting	5-6
5-3	Setting of SG and R3267 Series	5-7

1. INTRODUCTION

This chapter includes a product overview, information on the accessories, and notes on using this option and the calibration intervals.

1.1 Product Description

This option is designed to improve the Tx power measurement level accuracy in the 2 GHz band (1.8483 GHz to 2.1717 GHz) when the 3GPP level calibration option (OPT 11) is installed in the R3267 Series Spectrum Analyzer.

1.2 Accessories

Name of accessories	Type of name	Quantity	Remarks
R3267 Series OPT11 Operation manual	ER3267/73OPT11	1	English

1.3 Precautions in Use

1. Option labels

The number 11 is written on the INSTALLED OPTION NO label attached to the rear panel when the 3GPP calibration option is installed in the R3267 Series.

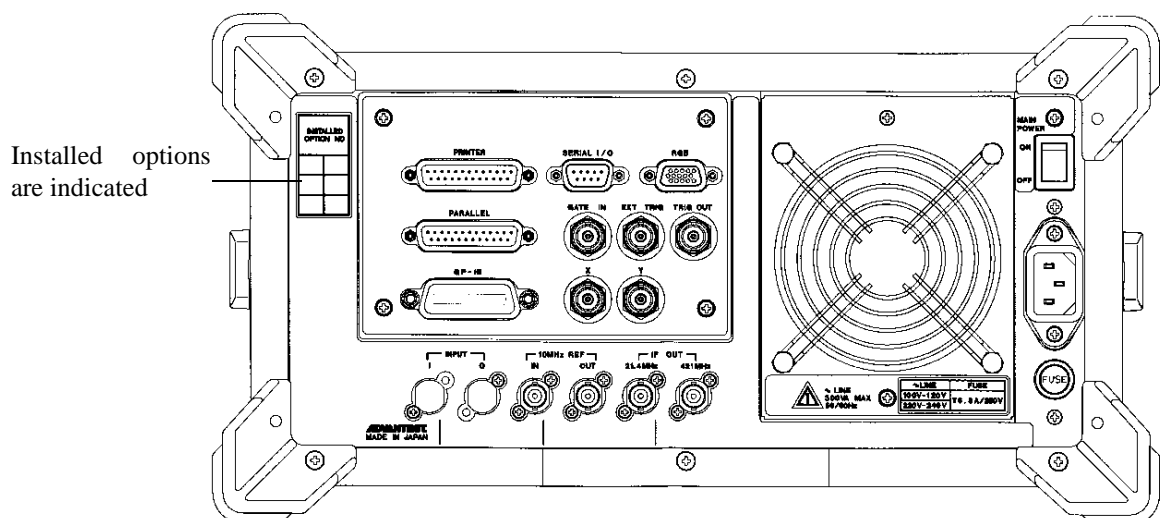

Figure 1-1 Installed Option Labels

1.4 Calibration

2. Performing a calibration

A calibration must be performed in order to improve the level accuracy of Tx Power measurement using the 3GPP level calibration function.

CAUTION: *The R3267 Series should be warmed up for at least 60 minutes before performing a calibration for OPT 11.*

a. Performing CAL ALL

Performs calibrations for all items according to the specifications for each item.

Be sure to calibrate the instrument using the procedure below before making measurements.

1. Connect the A01036-0150 cable that comes with the R3267 Series to the 30 MHz CAL OUT connector and the INPUT connector.
2. Press **SHIFT, 7(CAL)** and *Cal All*.
Cal All is performed (this takes approx. 9 minutes).

b. Performing Gain Cal

Performs a calibration for the Tx power measurement.

Perform this calibration when an ambient temperature changes.

1. Connect the A01036-0150 cable that comes with the R3267 Series to the 30 MHz CAL OUT connector and the INPUT connector.
2. Press **TRANSIENT, STD** and *Gain Cal*.
Gain Cal is performed (this takes approx. 20 seconds).

1.4 Calibration

When you want to calibrate the analyzer, please contact a sales representative.

Desirable Period	1 year
------------------	--------

2. OPERATION

This chapter describes 3GPP level calibration data and setting conditions, operating methods and provides measurement examples.

2.1 3GPP Level Calibration Data and the Setting Conditions

Table 2-1 shows the frequency range for 3GPP level calibration data and the frequency interval between calibrations.

Table 2-2 shows the setting conditions used for 3GPP level calibrations.

Table 2-1 Frequency Range for 3GPP Level Calibration Data and the Frequency

Frequency range	Frequency interval between calibrations
1.8483 GHz to 2.1717 GHz	6.6 MHz

Table 2-2 Setting Conditions Used for 3GPP Level Calibrations

Item	Setting
Input attenuator	10 dB to 50 dB
Tx Power measurement	Root Nyquist OFF Averaging times: 5
Number of calibrated points	50 points

2.2 Using 3GPP Level Calibration Data

Select whether or not 3GPP level calibration data is used.

NOTE: *The initial setting after the PRESET sets Level Cal Correction to ON.*

1. Press **TRANSIENT** and **STD**.
The menu that includes STD is displayed.
2. Press **Level Cal Correction ON/OFF**.
ON: 3GPP level calibration data is used for the measurement.
OFF: 3GPP level calibration data is not used for the measurement.

2.3 Measurement Sample

A method of measuring 2-GHz modulation signal Tx power, which uses 3GPP level calibration data, is explained in this sample.

Resetting the settings

1. Press **SHIFT** and **CONFIG(PRESET)**.
The initial settings are read.

Setting the measurement condition

2. Press **FREQ, 2** and **GHz**.
The center frequency is set to 2 GHz.

Level calibration for the R3267 Series

3. Connect the A01036-0150 cable that comes with the R3267 Series to the 30 MHz CAL OUT connector and the INPUT connector.
4. Press **TRANSIENT, STD** and **Gain Cal**.
Gain Cal is performed (this takes approx. 20 seconds).
The level is automatically calibrated for the R3267 Series.
5. Input a modulation signal to the INPUT connector on the R3267 Series.
6. Press **TRANSIENT, Modulation, Power, Tx Power** and **Auto Level Set**.
The reference level is automatically set.

2.3 Measurement Sample

7. Press **SINGLE**.

The modulation signal power is measured.

The level of the modulation signal is displayed on the R3267 Series screen.

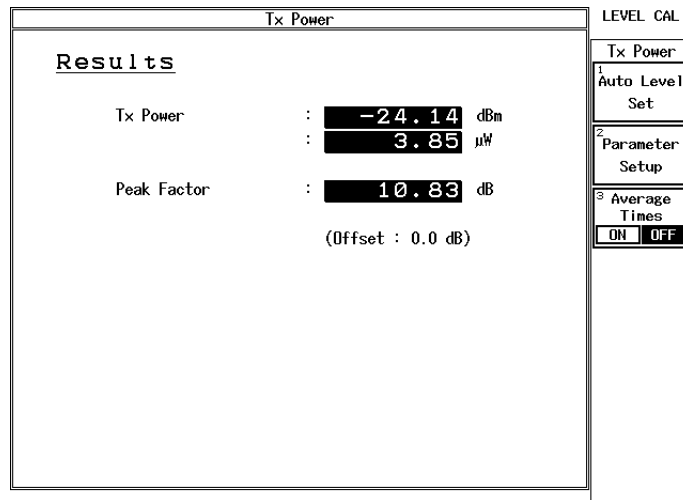

Figure 2-1 2 GHz Modulation Signal Measurement Sample (Using the 3GPP Level Calibration Function)

3. REFERENCE

This chapter describes the keys used with the 3GPP level calibration option (OPT 11).

For information on the other keys, refer to Section 3.3, “Functional Description” in R3267 Series Spectrum Analyzer Operation Manual.

3.1 Menu Index

<u>Operation Key</u>	<u>Pages</u>
Level Cal Correction ON/OFF	3-2
STD	3-2
TRANSIENT	3-2

3.2 Menu Map

3.2 Menu Map

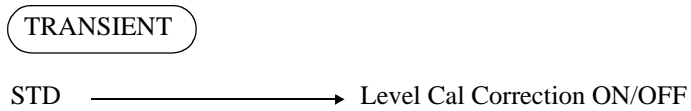

3.3 Functional Description

This section describes the keys used with the 3GPP level calibration option (OPT 11).

3.3.1 STD Menu

Press the **TRANSIENT** and **STD** keys displays *Level Cal Correction ON/OFF* is displayed.

<i>Level Cal Correction ON/OFF</i>	Toggles the level correction function on or off.
ON:	3GPP level calibration data is used for the measurement.
OFF:	3GPP level calibration data is not used for the measurement.

4. REMOTE PROGRAMMING

A list of GPIB codes required for remote control is shown in this section.

4.1 GPIB Command Index

This GPIB command index can be used as the index for this Chapter.

<u>GPIB Command</u>	<u>Pages</u>
LCALCORR OFF	4-2
LCALCORR ON	4-2

4.2 GPIB Command Codes

4.2 GPIB Command Codes

The following table list the GPIB commands by function.

Table 4-1 3GPP Level Calibration (OPT11)

Function		Listener Code	Talker Request	
			Code	Output Format
Level Cal	Level Cal Correction	LCALCORR ON	LCALCORR?	0: OFF
Correction				LCALCORR OFF

5. PERFORMANCE VERIFICATION TEST

A list of GPIB codes required for remote control is shown in this section.

5.1 GENERAL

5.1.1 Introduction

This chapter provides R3267 Series OPT11 performance verification test procedures.

5.1.2 Test Equipment

The Table 5-1 lists recommended test equipment.

The equipment needed to perform all of the performance test.

Equipment lists for individual tests are provided in each performance verification test.

CAUTION:

1. *The R3267 Series with OPT 11 to be tested should be warm up for at least 60 minutes before starting test.*
 2. *Make sure that the test equipment used meets its own published specifications.*
 3. *Any equipment that meets the critical specifications given in the table can be substituted for recommended models.*
-

5.1.3 Performance Verification Test Record Sheet

Table 5-1 Equipment List

No.	Description	Critical Specifications	Recommended Model	Manufacturer	Notes
1	RF Power Meter & RF Power Sensor	Frequency Range: 10 MHz to 3.0 GHz Power Range: 1 μ W to 100 mW VSWR: ≤ 1.1 Measurement accuracy: < 0.08 dB Note: Must be calibrated in advance.	NRVS & NRV-Z52	Rohde & Schwarz	PM/PS
2	Signal Generator	Frequency Range: 10 MHz to 3.0 GHz Output Level: -15 dBm to +10 dBm Aging Rate: $1 \times 10 \text{ exp-6/year}$	SMP03 equipped Option B11	Rohde & Schwarz	SG
3	RF Cable	Impedance: 50 Ω Connector Type: SMA(m)-SMA(m) Frequency Range: DC to 3.0 GHz VSWR: ≤ 1.1 Length: 0.7 m approx.	A01002	Advantest	RF_CBL1
4	RF Cable	Impedance: 50 Ω Connector Type: BNC(m)-BNC(m) Length: 15 cm approx.	A01036-0150	Advantest	RF_CBL2
5	RF Cable	Impedance: 50 Ω Connector Type: BNC(m)-BNC(m)	A01037-1500	Advantest	
6	Adapter	Type N(f)-SMA(f)	31 N-SMA-50-1/1	HUBER+SUHNER	Adap_1
7	Adapter	Type N(m)-SMA(f)	HRM-554S	Advantest	Adap_2
8	Adapter	Type N(m)-BNC(f)	JUG-201A-U	Advantest	Adap_3

5.1.3 Performance Verification Test Record Sheet

The performance verification test record sheet and performance check record sheet is provided at the end of this chapter.

The test record lists test specification and acceptable limits.

Recommend that make a copy of this table, record the complete test results on the copy, and keep the copy for calibration test record.

This record could prove invaluable in tracking gradual changes in test result over long period of time.

5.1.4 Performance Verification Procedure

Typeface conventions used in this manual.

*Panel keys and soft keys are printed in a contrasting typestyle to make them stand out from the text as follows:

Panel keys: Boldface type Example: **FREQ, FORMAT**

Soft keys: Boldface and Italic Example: ***Center, Trace Detector***

*When a series of key operations is described using a comma between two keys.

*There are various soft menus used to switch between two states such as ON/OFF and AUTO/MNL.

For example, when turning off the Display ON/OFF function, the annotation “***Display ON/OFF*** (OFF)” is used.

When switching the ATT AUTO/MNL function to MNL, the annotation “***ATT AUTO/MNL***(MNL)” is used.

5.2 Performance Verification Test Procedure

5.2.1 Level Calibration

1. Description

1. Measure level calibration measurement accuracy for 3GPP system.
2. Firstly measure a signal generator output signal level for several testing points by using RF power meter and RF power sensor as reference data.
3. Secondary, measure the signal generator output signal by Tx power measurement function of R3267 Series.
4. Compare the both measurement result of RF power meter and R3267 Series.
5. Record the difference as level calibration measurement accuracy.
6. Repeat measurement for input attenuator setting 10 dB through 50 dB. R3267 Series is phase locked with the signal generator.

2. Specification

At 25 °C, After gain calibration performed, ATT=AUTO, MinATT=ON

Measurement Accuracy:±0.4 dB

(Input signal level: +25 dBm to -50 dBm)

3. Equipment used

Signal Generator	:SG
RF Power Meter	:PM
RF Power Sensor	:PS
RF Cable	:CBL_1
RF Cable	:CBL_2
RF Cable	:CBL_3
Adapter	:Adap_1
Adapter	:Adap_2
Adapter	:Adap_3

4. Setup

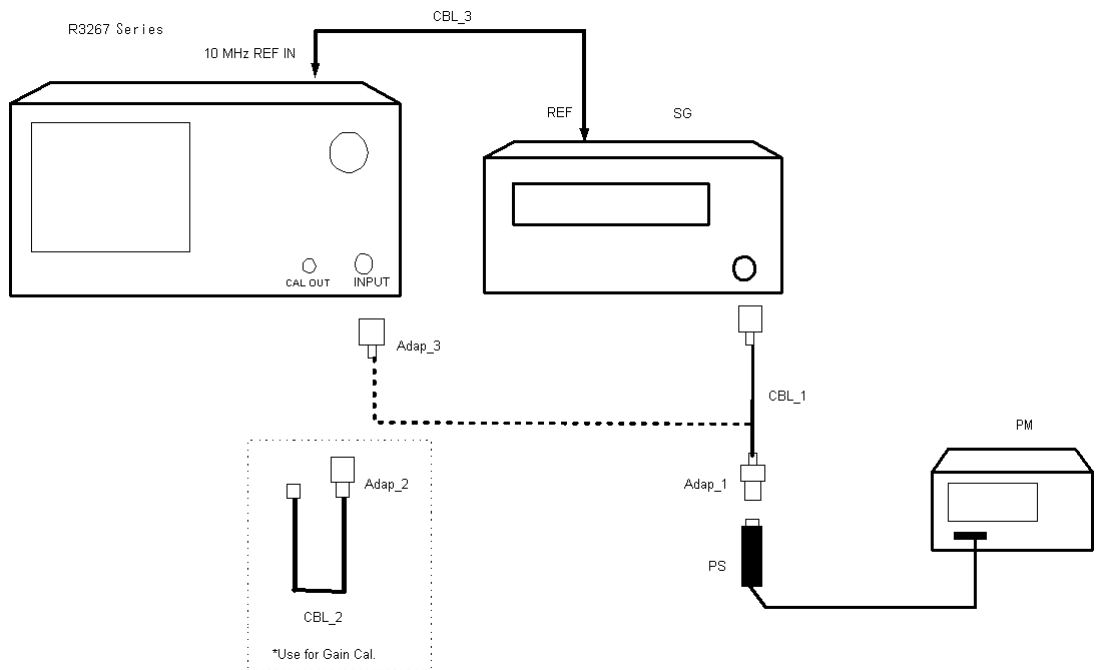

Figure 5-1 Setup of Level Calibration Test

5. Procedure

Part 1 Measuring SG output level

1. On the PM, set dBm display mode.
2. On the PM, perform ZERO.
3. Connect equipment as shown in Figure 5-1.
4. On the SG, set control as follow;
Output Frequency:1.8483 GHz
5. On the PM, set a correction data for 1.8483 GHz.
6. While monitoring PM measurement data, adjust SG output level so that measurement data to be -12 ± 0.1 dBm.
7. Record the PM measurement data in the PM column on the performance verification test record sheet for attenuator setting 10 dB through 50 dB.
8. On the SG, set control as follow;
Output Frequency:1.9011 GHz
9. Record the PM measurement data in the PM column on the performance verification test record sheet for attenuator setting 10 dB through 50 dB.

5.2.1 Level Calibration

10. Repeat steps 8. through 9. for each frequency listed on Table 5-2.

Table 5-2 List for SG and PM Correction Data Setting

SG Output Frequency (GHz)	PM Correction Data (GHz)
1.9473	1.9473
2.0001	2.0001
2.0529	2.0529
2.0991	2.0991
2.1519	2.1519
2.1717	2.1717

Part 2 Performing Gain Cal.

11. Connect CAL. OUT and INPUT by using CBL_2 and Adap_3.
12. On the R3267 Series, press keys as follows to preset.
SHIFT, CONFIG (PRESET)
13. On the R3267 Series, press keys as follows to perform a gain calibration.
TRANSIENT, STD, Gain Cal
14. After the gain calibration sequence has completed, disconnect CBL_2 and Adap_2.

Part 3 Performing level calibration test

15. Connect SG output and R3267 Series INPUT by using CBL_1 and Adap_3, as shown dashed line in Figure 1.

[INPUT ATT 10 dB Setting]

16. On the R3267 Series, press keys as follows to set an input attenuator to 10 dB.
ATT, ATT AUTO/MNL(MNL), 1, 0, GHz (dB)
17. On the SG, set control as follow;
Output Frequency: 1.8483 GHz
18. On the R3267 Series, set control as follow;
Center Frequency:1.8483 GHz
19. On the R3267 Series, press keys as follows to perform auto level set function.
TRANSIENT, Modulation, Power, Tx Power, Auto Level Set
20. On the R3267 Series, after the auto level function has completed, press **SINGLE** for a single Tx Power measurement.

21. Record the measurement result in the Tx Power column on the performance verification test record sheet.
22. Calculate measurement accuracy subtracting PM measurement result from Tx Power.
Record the result in the actual column on the performance verification test record sheet.
23. Repeat steps 17. through 22. for each frequency listed on Table 5-3.

Table 5-3 Setting of SG and R3267 Series

SG Output Frequency (GHz) in step 17	R3267 Series Center Frequency (GHz) in step 18
1.9011	1.9011
1.9473	1.9473
2.0001	2.0001
2.0529	2.0529
2.0991	2.0991
2.1519	2.1519
2.1717	2.1717

[INPUT ATT 20 dB Setting]

24. On the R3267 Series, press keys as follows to set the input attenuator to 20 dB.
ATT, ATT AUTO/MNL(MNL), 2, 0, GHz(dB)
25. Repeat steps 17. through 23.

[INPUT ATT 30 dB Setting]

26. On the R3267 Series, press keys as follows to set the input attenuator to 30 dB.
ATT, ATT AUTO/MNL(MNL), 3, 0, GHz(dB)
27. Repeat steps 17. through 23.

[INPUT ATT 40 dB Setting]

28. On the R3267 Series, press keys as follows to set the input attenuator to 40 dB.
ATT, ATT AUTO/MNL(MNL), 4, 0, GHz(dB)
29. Repeat steps 17. through 23.

[INPUT ATT 50 dB Setting]

30. On the R3267 Series, press keys as follows to set the input attenuator to 50 dB.
ATT, ATT AUTO/MNL(MNL), 5, 0, GHz(dB)
31. Repeat steps 17. through 23.

5.3 Performance Verification Test Record Sheet

5.3 Performance Verification Test Record Sheet

ATT=10 dB		R3267 Series Tx Power Measured value(dBm)	Specification			Result
Frequency (GHz)	Measured value of power meter (dBm)		Min. (dB)	Measured error (dB)	Max. (dB)	Pass/Fail
1.8483			-0.4		0.4	
1.9011			-0.4		0.4	
1.9473			-0.4		0.4	
2.0001			-0.4		0.4	
2.0529			-0.4		0.4	
2.0991			-0.4		0.4	
2.1519			-0.4		0.4	
2.1717			-0.4		0.4	

ATT=20 dB		R3267 Series Tx Power Measured value(dBm)	Specification			Result
Frequency (GHz)	Measured value of power meter (dBm)		Min. (dB)	Measured error (dB)	Max. (dB)	Pass/Fail
1.8483			-0.4		0.4	
1.9011			-0.4		0.4	
1.9473			-0.4		0.4	
2.0001			-0.4		0.4	
2.0529			-0.4		0.4	
2.0991			-0.4		0.4	
2.1519			-0.4		0.4	
2.1717			-0.4		0.4	

ATT=30 dB		R3267 Series Tx Power Measured value(dBm)	Specification			Result
Frequency (GHz)	Measured value of power meter (dBm)		Min. (dB)	Measured error (dB)	Max. (dB)	Pass/Fail
1.8483			-0.4		0.4	
1.9011			-0.4		0.4	
1.9473			-0.4		0.4	
2.0001			-0.4		0.4	
2.0529			-0.4		0.4	
2.0991			-0.4		0.4	
2.1519			-0.4		0.4	
2.1717			-0.4		0.4	

ATT=40 dB		R3267 Series Tx Power Measured value(dBm)	Specification			Result
Frequency (GHz)	Measured value of power meter (dBm)		Min. (dB)	Measured error (dB)	Max. (dB)	Pass/Fail
1.8483			-0.4		0.4	
1.9011			-0.4		0.4	
1.9473			-0.4		0.4	
2.0001			-0.4		0.4	
2.0529			-0.4		0.4	
2.0991			-0.4		0.4	
2.1519			-0.4		0.4	
2.1717			-0.4		0.4	

5.3 Performance Verification Test Record Sheet

ATT=50 dB Frequency (GHz)	Measured value of power meter (dBm)	R3267 Series Tx Power Measured value(dBm)	Specification			Result
			Min. (dB)	Measured error (dB)	Max. (dB)	Pass/Fail
1.8483			-0.4		0.4	
1.9011			-0.4		0.4	
1.9473			-0.4		0.4	
2.0001			-0.4		0.4	
2.0529			-0.4		0.4	
2.0991			-0.4		0.4	
2.1519			-0.4		0.4	
2.1717			-0.4		0.4	

6. SPECIFICATIONS

The specifications for the 3GPP level calibration option (OPT 11) are shown below.

Calibration frequency range		1848.3 MHz to 2171.7 MHz
Level measurement range		+25 dBm to -60 dBm
Level measurement accuracy	Measurement error (When ATT is set to AUTO and Min ATT is set to ON after Gain Cal is performed at 25°C)	$\leq \pm 0.4$ dB (+25 dBm to -50 dBm) $\leq \pm 0.6$ dB (-50 dBm to -60 dBm)
	Measurement linearity	$\leq \pm 0.2$ dB (0 dB to -30 dB)
Gain Cal error due to temperature		0.015 dB/°C
Calibration period		1 year

APPENDIX

A.1 Error Message List

Code	Error message	Description
752	Invalid Level Cal Correction data. Contact qualified engineer.	

ALPHABETICAL INDEX

	[Numerics]		
3GPP Level Calibration Data		2-2	
3GPP Level Calibration Data and the Setting Conditions		2-1	
	[A]		
Accessories		1-1	
	[C]		
Calibration		1-2	
	[E]		
Error Message List		A-1	
	[F]		
Functional Description		3-2	
	[G]		
GPIO Command Codes		4-2	
GPIO Command Index		4-1	
	[I]		
INTRODUCTION		1-1	
	[L]		
Level Cal Correction ON/OFF		3-2	
Level Calibration		5-4	
	[M]		
Measurement Sample		2-3	
Menu Index		3-1	
Menu Map		3-2	
	[O]		
OPERATION		2-1	
	[P]		
Performance Verification Procedure		5-3	
PERFORMANCE VERIFICATION TEST		5-1	
Performance Verification Test Procedure		5-4	
Performance Verification Test Record Sheet		5-2, 5-8	
Precautions in Use		1-1	
Product Description		1-1	
	[R]		
REFERENCE		3-1	
REMOTE PROGRAMMING		4-1	
	[S]		
SPECIFICATIONS		6-1, A-1	
STD		3-2	
STD Menu		3-2	
	[T]		
Test Equipment		5-1	
TRANSIENT		3-2	

IMPORTANT INFORMATION FOR ADVANTEST SOFTWARE

PLEASE READ CAREFULLY: This is an important notice for the software defined herein. Computer programs including any additions, modifications and updates thereof, operation manuals, and related materials provided by ADVANTEST (hereafter referred to as "SOFTWARE"), included in or used with hardware produced by ADVANTEST (hereafter referred to as "PRODUCTS").

SOFTWARE License

All rights in and to the SOFTWARE (including, but not limited to, copyright) shall be and remain vested in ADVANTEST. ADVANTEST hereby grants you a license to use the SOFTWARE only on or with ADVANTEST PRODUCTS.

Restrictions

- (1) You may not use the SOFTWARE for any purpose other than for the use of the PRODUCTS.
- (2) You may not copy, modify, or change, all or any part of, the SOFTWARE without permission from ADVANTEST.
- (3) You may not reverse engineer, de-compile, or disassemble, all or any part of, the SOFTWARE.

Liability

ADVANTEST shall have no liability (1) for any PRODUCT failures, which may arise out of any misuse (misuse is deemed to be use of the SOFTWARE for purposes other than it's intended use) of the SOFTWARE. (2) For any dispute between you and any third party for any reason whatsoever including, but not limited to, infringement of intellectual property rights.

LIMITED WARRANTY

1. Unless otherwise specifically agreed by Seller and Purchaser in writing, ADVANTEST will warrant to the Purchaser that during the Warranty Period this Product (other than consumables included in the Product) will be free from defects in material and workmanship and shall conform to the specifications set forth in this Operation Manual.
2. The warranty period for the Product (the "Warranty Period") will be a period of one year commencing on the delivery date of the Product.
3. If the Product is found to be defective during the Warranty Period, ADVANTEST will, at its option and in its sole and absolute discretion, either (a) repair the defective Product or part or component thereof or (b) replace the defective Product or part or component thereof, in either case at ADVANTEST's sole cost and expense.
4. This limited warranty will not apply to defects or damage to the Product or any part or component thereof resulting from any of the following:
 - (a) any modifications, maintenance or repairs other than modifications, maintenance or repairs (i) performed by ADVANTEST or (ii) specifically recommended or authorized by ADVANTEST and performed in accordance with ADVANTEST's instructions;
 - (b) any improper or inadequate handling, carriage or storage of the Product by the Purchaser or any third party (other than ADVANTEST or its agents);
 - (c) use of the Product under operating conditions or environments different than those specified in the Operation Manual or recommended by ADVANTEST, including, without limitation, (i) instances where the Product has been subjected to physical stress or electrical voltage exceeding the permissible range and (ii) instances where the corrosion of electrical circuits or other deterioration was accelerated by exposure to corrosive gases or dusty environments;
 - (d) use of the Product in connection with software, interfaces, products or parts other than software, interfaces, products or parts supplied or recommended by ADVANTEST;
 - (e) the occurrence of an event of force majeure, including, without limitation, fire, explosion, geological change, storm, flood, earthquake, tidal wave, lightning or act of war; or
 - (f) any negligent act or omission of the Purchaser or any third party other than ADVANTEST.
5. **EXCEPT TO THE EXTENT EXPRESSLY PROVIDED HEREIN, ADVANTEST HEREBY EXPRESSLY DISCLAIMS, AND THE PURCHASER HEREBY WAIVES, ALL WARRANTIES, WHETHER EXPRESS OR IMPLIED, STATUTORY OR OTHERWISE, INCLUDING, WITHOUT LIMITATION, (A) ANY WARRANTY OF MERCHANTABILITY OR FITNESS FOR A PARTICULAR PURPOSE AND (B) ANY WARRANTY OR REPRESENTATION AS TO THE VALIDITY, SCOPE, EFFECTIVENESS OR USEFULNESS OF ANY TECHNOLOGY OR ANY INVENTION.**
6. **THE REMEDY SET FORTH HEREIN SHALL BE THE SOLE AND EXCLUSIVE REMEDY OF THE PURCHASER FOR BREACH OF WARRANTY WITH RESPECT TO THE PRODUCT.**
7. **ADVANTEST WILL NOT HAVE ANY LIABILITY TO THE PURCHASER FOR ANY INDIRECT, INCIDENTAL, SPECIAL, CONSEQUENTIAL OR PUNITIVE DAMAGES, INCLUDING, WITHOUT LIMITATION, LOSS OF ANTICIPATED PROFITS OR REVENUES, IN ANY AND ALL CIRCUMSTANCES, EVEN IF ADVANTEST HAS BEEN ADVISED OF THE POSSIBILITY OF SUCH DAMAGES AND WHETHER ARISING OUT OF BREACH OF CONTRACT, WARRANTY, TORT (INCLUDING, WITHOUT LIMITATION, NEGLIGENCE), STRICT LIABILITY, INDEMNITY, CONTRIBUTION OR OTHERWISE.**

CUSTOMER SERVICE DESCRIPTION

In order to maintain safe and trouble-free operation of the Product and to prevent the incurrence of unnecessary costs and expenses, ADVANTEST recommends a regular preventive maintenance program under its maintenance agreement.

ADVANTEST's maintenance agreement provides the Purchaser on-site and off-site maintenance, parts, maintenance machinery, regular inspections, and telephone support and will last a maximum of ten years from the date the delivery of the Product. For specific details of the services provided under the maintenance agreement, please contact the nearest ADVANTEST office listed at the end of this Operation Manual or ADVANTEST's sales representatives.

Some of the components and parts of this Product have a limited operating life (such as, electrical and mechanical parts, fan motors, unit power supply, etc.). Accordingly, these components and parts will have to be replaced on a periodic basis. If the operating life of a component or part has expired and such component or part has not been replaced, there is a possibility that the Product will not perform properly. Additionally, if the operating life of a component or part has expired and continued use of such component or part damages the Product, the Product may not be repairable. Please contact the nearest ADVANTEST office listed at the end of this Operation Manual or ADVANTEST's sales representatives to determine the operating life of a specific component or part, as the operating life may vary depending on various factors such as operating condition and usage environment.

CLAIM FOR DAMAGE IN SHIPMENT TO ORIGINAL BUYER

The product should be thoroughly inspected immediately upon original delivery to buyer. All material in the container should be checked against the enclosed packing list or the instruction manual alternatively. ADVANTEST will not be responsible for shortage unless notified immediately.

If the product is damaged in any way, a claim should be filed by the buyer with carrier immediately. (To obtain a quotation to repair shipment damage, contact ADVANTEST or the local supplier.) Final claim and negotiations with the carrier must be completed by buyer.

SALES & SUPPORT OFFICES

Advantest America Measuring Solutions, Inc. (North America)

New Jersey Office

258 Fernwood Avenue, Edison, NJ 08837

Phone: (1) (732) 346-2600 Facsimile: (1) (732) 346-2610

Santa Clara Office

3201 Scott Blvd., Santa Clara, CA 95054

Phone: (1) (408) 988-7700 Facsimile: (1) (408) 987-0688

ROHDE & SCHWARZ Engineering and Sales GmbH (Europe)

Mühlendorfstraße 15, D-81671 München, Germany

P.O.B. 80 14 29, D-81614 München, Germany

Phone: (49) (89) 4129-13711 Facsimile: (49) (89) 4129-13723

Advantest (Singapore) Pte. Ltd. (Singapore)

438A Alexandra Road, #8-03/06

Alexandra Technopark, Singapore 119967

Phone: (65) (6) 274-3100 Facsimile: (65) (6) 274-4055

Advantest Korea Co., Ltd. (Korea)

16Fl., MIRAEWASARAM Bldg., 942-1

Daechi-Dong, Kangnam-Ku, Seoul, Korea

Phone: (82) (02) 3452-7710 Facsimile: (82) (02) 3452-7970

Advantest (Suzhou) Co., Ltd. (China)

5F, No. 46 Factory Building,

No. 555 Gui Ping Road, Shanghai, China 200233

Phone: (86) (21) 6485-2725 Facsimile: (86) (21) 6485-2726

Technology Support on the Leading Edge

ADVANTEST®

ADVANTEST CORPORATION

Shinjuku-NS Building, 4-1, Nishi-Shinjuku 2-chome, Shinjuku-ku, Tokyo 163-0880, Japan
Phone:+81-3-3342-7500 Facsimile:+81-3-5322-7270 Telex:232-4914 ADVAN J